

LARGE AND HIGHLY STABLE STRUCTURES MADE OF SiC

M. Bougoin, J. Lavenac

Boostec (Mersen group), Zone Industrielle 65460 Bazet, France,
michel.bougoin@mersen.com jerome.lavenac@mersen.com

ABSTRACT

The Boostec® SiC material appears very attractive for manufacturing large space telescopes, thanks to its high specific stiffness and its thermal stability. Its physical properties are perfectly isotropic and it is remarkably more stable than the glass-ceramics in time and also against space radiations. This sintered SiC material has been fully qualified for application at cryogenic temperature. Thanks to its good mechanical strength and toughness, it can be used for making not only the mirrors but also the structure and the focal plane hardware of the optical instruments, thus making “all in SiC” and possibly “athermal” telescopes.

The present paper describes the Boostec® SiC properties and then its manufacturing technology. Some examples of the structures of the Multi Spectral Imaging instruments of Sentinel-2 and also the very large Gaia one are further developed.

1. INTRODUCTION

The space optics of the last decade and the following ones need very large mirrors like Herschel Φ 3.5 m primary mirror [1] but also large and stiff structures which must be extremely stable against thermo-elastic stresses. JWST-Nirspec Optical Bench [2], Gaia [3] and Sentinel-2 MSI [4] are some examples of those, where the Boostec® SiC material turned out to be indispensable, thanks to its combination of very suitable properties. Now in 2012, seven “all-SiC” telescopes taking profit from Boostec/Astrium technology are successfully operating in space; Herschel which is by far the largest space telescope is one of them.

2. BOOSTEC® SiC MATERIAL

BOOSTEC material is a **sintered silicon carbide**. Its key properties are a high specific stiffness (420GPa / 3.15g.cm⁻³) combined with a high thermal stability (180W.m⁻¹.K⁻¹ / 2.2 . 10⁻⁶ K⁻¹).

In comparison with the even most recently developed reaction bonded SiC including short chopped carbon fibers [5], it features 24% higher thermal conductivity, 25% higher bending strength, 20% higher stiffness and similar toughness.

It shows a better stability in time and a better resistance to the space radiations than the glass-ceramics which have been commonly used up to now for the space mirrors.

Thanks to its isotropic microstructure, the physical properties of this alpha type SiC are perfectly isotropic and reproducible inside a same large part or from batch to batch. In particular, no CTE mismatch has been measurable, with accuracy in the range of 10⁻⁹ K⁻¹.

Properties	Typical Values @ 293 K
Density	3.15 g.cm ⁻³
Young's modulus	420 GPa
Bending strength / Weibull modulus (coaxial double ring bending test)	400 MPa / 11
Poisson's ratio	0.17
Toughness (K _{IC})	3.5 MPa.m ^{1/2}
Coefficient of Thermal Expansion (CTE)	2.2 . 10 ⁻⁶ K ⁻¹
Thermal Conductivity	180 W.m ⁻¹ .K ⁻¹
Electrical conductivity	10 ⁵ Ω.m

Table 1. Basic properties of Boostec® SiC

The sintered SiC of BOOSTEC shows no mechanical fatigue, no outgassing and no moisture absorption nor release. It has been fully qualified for space application at cryogenic temperature such as NIRSpec instrument which will be operated at only 30K [2].

Its CTE is decreasing from 2.2 . 10⁻⁶ K⁻¹@ room temperature down to 0.2 . 10⁻⁶ K⁻¹@ 100K and nearly 0.0 . 10⁻⁶ K⁻¹ between 0 and 35K.

3. BOOSTEC SiC TECHNOLOGY

3.1 Manufacturing monolithic SiC parts

Commonly, BOOSTEC manufactures monolithic SiC parts of up to 1.7m x 1.2m x 0.6m (or Φ 1.25 m). The flight models are manufactured with the sequence of steps shown in Fig. 1.

The parts are machined very close to the final shape at the green stage i.e. when the material is still very soft (similar to chalk). This is high speed machining; typically, green parts of 1 meter are machined within 1 week while lightweighting such a glass-ceramic blank should take several months. Furthermore, in BOOSTEC process, the collected chips are reused for producing new raw material. During the last ten years, the reliability and also the speed of this process have been continuously improved. New software has been invested for programming the CNC milling machines and also to verify the machining programs, thus allowing the green machining of very complex 3D shapes with a high

reliability. These are some of the reasons why BOOSTEC process is so cost effective, reliable and quick.

These shaped parts are then sintered by heating-up to around 2100°C under a protective atmosphere, thus transforming the compacted powder blank into a hard and stiff ceramic material. The “as-sintered” surfaces look highly smooth (typically Ra 0.4 μm); they can be used as is, without any sand blasting or any other rework. The interfaces of the structures are then generally ground in order to obtain accurate shape (from 1 μm up to 50 μm) and location; they are optionally further lapped or polished for an even better accuracy and a smaller roughness.

The mechanically loaded parts are generally proof-tested in order to avoid defects which could be hidden in the material; even if unlikely, this is above all an easy way to really prove that the relevant SiC part is able to withstand with the predicted most critical loads. The parts are checked crack-free with help of UV fluorescent dye penetrant, before and after such a proof-test. They are measured with a large size accurate CMM or a laser tracker.

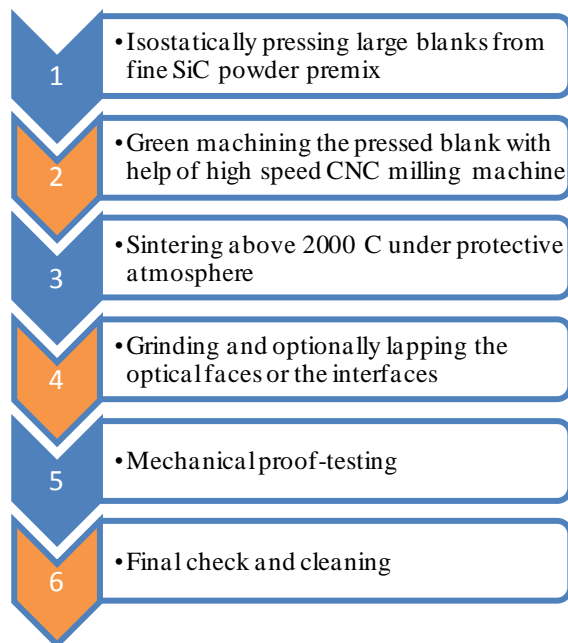

Figure 1. Manufacturing process for monolithic parts

3.2 Manufacturing very large SiC parts

The SiC parts the size of which exceeds 1.7m x 1.2m are obtained by **brazing** the assembly of previously sintered and ground pieces. The joint is made of a silicon alloy and it is generally less than 0.05 mm thick. The SiC parts are all joined together in a single run; their relative location is kept better than +/- 0.1 mm from the prediction to the final measurement, at the end of the brazing process.

This process has been developed a decade ago for the Herschel primary mirror which is made of 12 SiC

segments brazed together. Since that, it has been successfully used for the assembly of the Gaia torus (§ 4.2) and the main structure of Sentinel-2 MSI (§ 5.2 here after).

4. THE STRUCTURE OF GAIA INSTRUMENT

4.1 The GAIA payload module (PLM)

GAIA is the 6th cornerstone of the ESA scientific program; it will provide positional, photometric and radial velocity measurements of about one billion star of our galaxy, with an unprecedented accuracy. The large payload has been designed by ASTRUM [3][6]. It includes three science instruments:

- i. **The Astro** which is devoted to the star angular position measurements (astrometry),
- ii. **The Blue & Red Photometers** which provide continuous star spectra on 60 pixels in the band 330-1000nm for astrophysics and Astro chromaticity calibration,
- iii. **The Radial Velocity Spectrometer (RVS)** which provides high resolution spectra on 1260 pixels in the narrow band 847-874nm and radial velocity measurements by Doppler effect.

Two 1.5m TMAs point towards two directions forming a “Basic Angle” of 106.5°. The beams are then recombined with help of two folding mirrors, thus allowing them sharing a single large focal plane [7]. The astrometric accuracy (10-25μarcsec at magnitude 15) relies on the very high stability of this “Basic Angle” (7μarcsec over 6 hours). The SiC material appeared essential for obtaining the required **mechanically and thermally ultra-stable payload**.

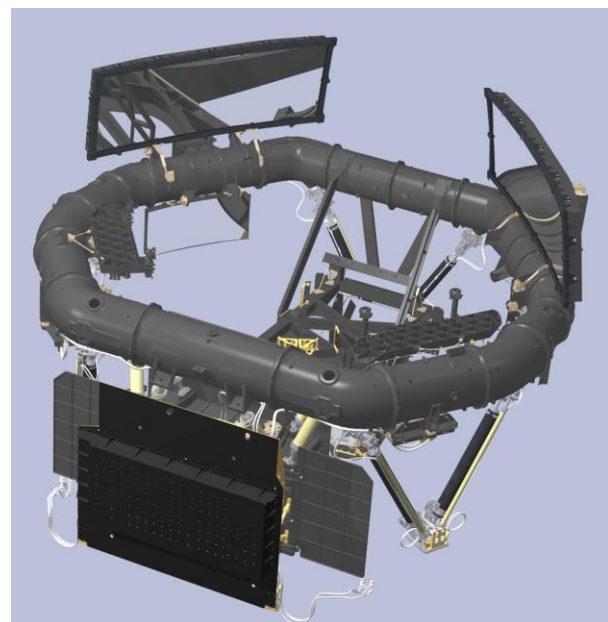

Figure 2. Overview of the GAIA PLM

The GAIA Payload Module features all-SiC architecture i.e. all the mirrors are made of Boostec® SiC but also all main structural parts, as described here after. It has been designed with a quasi-static load of 9g longitudinal and 4g lateral.

4.2 The Torus

The highly stiff and stable main bench of the GAIA instrument is named the Torus. It is hollow and quasi octagonal shaped, 3m in diameter. It includes 17 segments (all different, 0.5 - 1m in size) forming the large ring plus 2 additional brackets for M1 mirrors attachments; all of them have been joined by brazing, thus giving the required stiffness and stability. All SiC structural parts have a lot of accurate interfaces. In particular, the torus features i) 6 “BRM” for bolting bipods for attachment to the satellite, ii) 6 for gluing the SiC struts which hold a central baseplate named the “Folding Optics Structure” (§ 4.3), iii) 6 for bolting the thermally insulating legs which hold the 180 kg focal plane (§ 4.4), iv) 6 for bolting two optical benches named the “Basic Angle Monitoring” (§ 4.5), v) 20 for gluing the bipods which hold the 2 M1 and the 2 M3 mirrors, etc...

All these interfaces have been grinded and lapped very accurately on each individual torus segment before its brazing assembly. Each segment has also been mechanically proof-tested.



Figure 3. One of the torus segments

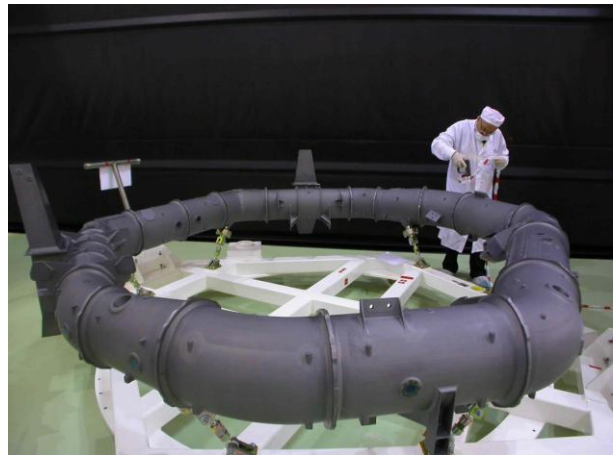

Figure 4. The torus, as delivered to Astrium (< 200kg)

The brazing assembly required quite innovative technology. The 19 SiC parts had to be located accurately until the end of the brazing run which is performed around 1500°C. An ultrasound based technique has been developed specifically with the CEA (the French Nuclear Agency) for checking all the brazed joints. It allowed the detection and the cartography of possible voids down to a few mm². No significant defects were found in the brazed joints.

4.3 The Folding Optics Structure (FOS)

The FOS is a very lightweight SiC baseplate (1.44m x 0.87m x 0.14m; 21kg) which holds several optical items including the 2 large folding mirrors M5 and M6 and the RVS. It is linked to the torus through epoxy glued struts which are also made of SiC.

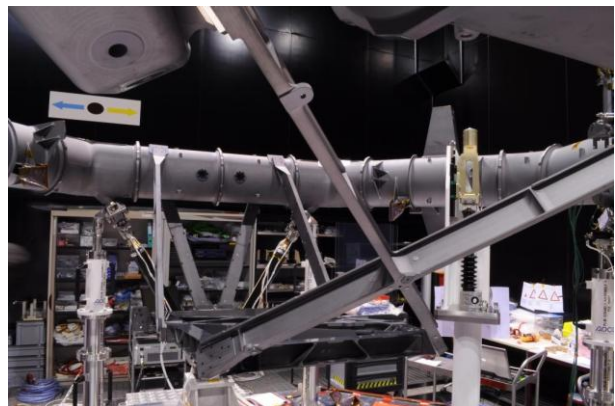

Figure 5. The FOS is attached to the torus

The mass of the so obtained main bench is 270kg including its bipods and 230 kg SiC (torus, FOS and struts). In total, this structure holds 420 kg of hardware but this mass is not uniformly distributed.

4.4 The Focal Plane

This “billion pixel” camera will be the largest in the Solar System [7]. Its 106 CCDs are mounted on “SiC packages” by their manufacturer, E2V UK. These

assemblies are then bolted by Astrium on the CCDs Supporting Structure (the CSS, 1.15m x 0.53m; 11kg).

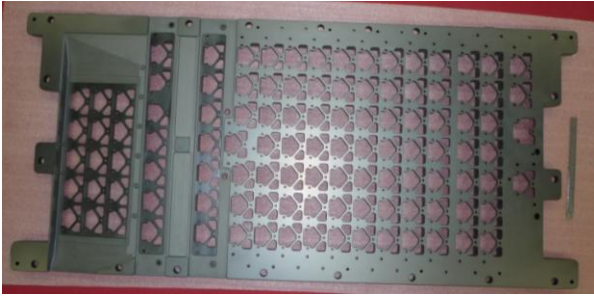

Figure 6. The CCD supporting structure

Beside the main Astro CCD plane, the CSS features 3 other planes which are tilted with different angles. This base-plate is then bolted on the Cold Radiator (1.17m x 0.62m x 0.41m - 38kg). All the useful areas of these both large SiC structures have been polished to a local flatness of 1 μ m. The Cold Radiator is very large in its 3 dimensions (Fig. 7). It includes 6 accurately located interfaces areas which allow to hanging it under the torus.



Figure 7. The Cold Radiator

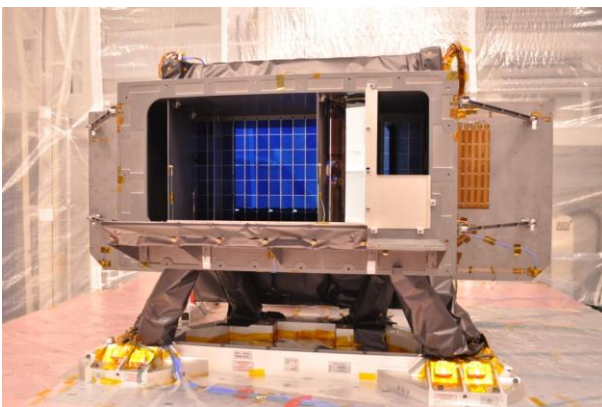

Figure 8. The FM focal plane

The focal plane includes other SiC parts such as additional radiator panels, struts and internal vanes (Fig. 8).

4.5 The Basic Angle Monitoring (BAM)

The GAIA PLM includes an interferometer made of two similar optical benches for Basic Angle Monitoring

purpose. They have been designed by TNO (NL) in close collaboration with Astrium. Each of them is based on a **very lightweight base-plate**.



Figure 9. The integrated BAM2
image courtesy of TNO / Astrium / ESA

The largest one, called “BAM2” is made of a stiffened plate including 1 mm thick ribs on its back side and 15 integrated brackets on its front side. Its overall size is 0.93m x 0.28m x 0.11m and it weighs only 5.6kg. The brackets are accurately finished for bolting a lot of small SiC mirrors and other optics. Two all-SiC periscopes are also bolted on the bench (Fig. 9).

4.6 The RVS structure

The RVS includes several optics all based on quite heavy fused silica parts (208mm x 160mm). They are mounted into a SiC structure through bipods which are glued to the silica and bolted to the SiC. The RVS design was challenging in terms of optical requirements, mass, stiffness, stability, mounting of optics and thermal environment (@ 130K) [3]. This is the reason why Astrium has selected Boostec® SiC and designed a very lightweight C shaped structure. A lot of small SiC brackets have been glued inside the main structure. The RVS is mounted on the FOS with help of 3 glued metallic blades.

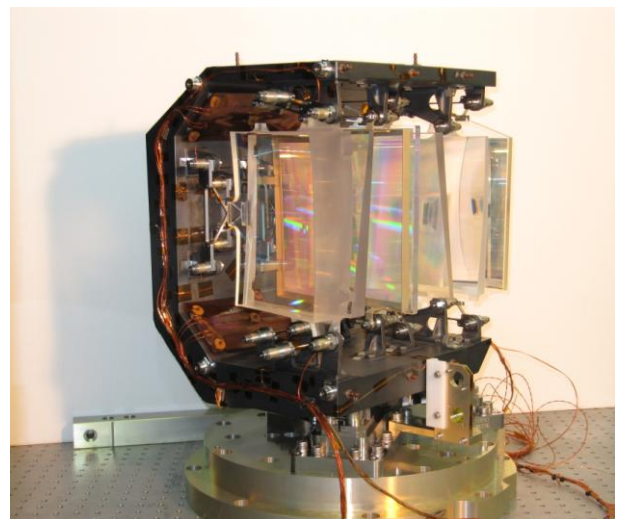

Figure 10. The Radial Velocity Spectrometer

The mass of the final RVS assembly presented here above is 27kg and its eigen frequency is 130Hz.

5. THE STRUCTURE OF SENTINEL-2 MSI

5.1 The Sentinel-2 Multi Spectral Instrument

The Sentinel-2 mission is a major part of the GMES (Global Monitoring for Environment and Security) program which has been set up by the European Union, on a joint initiative with the European Space Agency. MSI will provide optical images in 13 spectral bands, in the visible and also the near infra-red range, with a 10 to 60 m resolution and a 290 km wide swath [8].

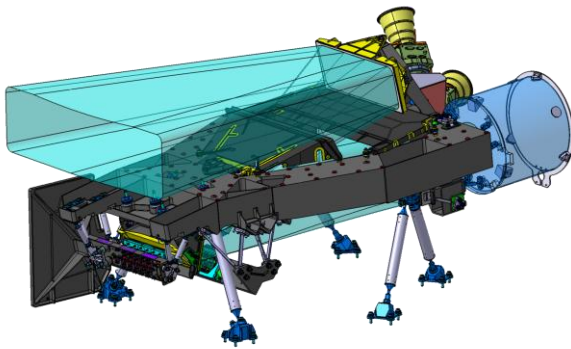

Figure 11. Overview of the Sentinel-2 MSI

Similarly as for GAIA, the Boostec SiC technology turned out to be very helpful to reach the required thermo-mechanical stability. Then, the MultiSpectral Instrument which has been designed by Astrium features “all-SiC” large TMA (Three Mirror Anastigmat) telescope. The 3 mirrors (M1, M2 and M3), the 2 focal planes hardware and also the main structure are made of SiC [4] [8]. The main characteristics of the telescope are the followings:

- Mass # 120 kg,
- 1st eigen frequency # 65 Hz,
- Operational stability: angular # 3 μ rad, WFE 20 nm and defocus 3 μ m.

5.2 The main structure of MSI

The main structure of MSI holds the 3 mirrors, the beam splitter device, the 2 focal planes and 3 stellar sensors. It is furthermore mounted on the satellite through 3 bolted bipods. It has then a lot of interfaces which have been lapped in order to obtain the required flatness (down to 1 μ m) and location (typically 0.1mm). The main structure is manufactured by brazing the assembly of a base-plate with a M1 bracket and a M3 one.



Figure 12. The main structure of Sentinel-2 MSI

The main structure is sized 1.47m long x 0.93m wide x 0.62 m high and it weighs only 44kg.

5.3 The Focal Plane VNIR and SWIR structures

A dichroic splits the beam towards two separate focal planes. The VNIR uses Si CMOS detectors while the SWIR has HgCdTe ones which are individually mounted on small SiC packages. All detectors are bolted on a SiC structure which also integrates a SiC panel acting as a radiator, thus allowing a passive cooling (see left area of Fig.13 and bottom area of Fig.14). Then, ingeniously and efficiently, both functions of detectors support and radiator are implemented in a single SiC piece.



Figure 13. The VNIR detector support



Figure 14. The SWIR detector support

These structures are fixed to the main structure through 3 bolted bipods. The overall area where the detectors have to be bolted is lapped down to a flatness of $1\mu\text{m}$.

6. CONCLUSION

Seven “all-SiC” telescopes including the impressive Herschel observatory are now successfully operating in space. The Gaia instrument has successfully passed a lot of thermo-mechanical tests at STM or sub-assembly level. Its integration is in good progress in Astrium and it is on the good way for a successful delivery by the end of 2012. On the other hand, Astrium has now received all the SiC hardware of the 1st Sentinel-2 MSI and its integration is also in good progress. Gaia and Sentinel-2 MSI are full of examples of highly stable and stiff structures, some of them being very large. All these successful experiences clearly show that the pioneering time is behind Boostec team and that this technology is fully mature and ready for the future ESA projects like EUCLID and SPICA.

ACKNOWLEDGEMENTS

We are extremely grateful to Rudolf Schmidt, Giuseppe Sarri and Philippe Gare for ESA side as well as Michel Duran, Vincent Poinignon and Philippe Charvet in

ASTRIUM who have accepted to pioneer the use of our SiC technology for GAIA project.

François Spoto (ESA) and Vincent Cazaubiel (ASTRIUM) have put their trust in BOOSTEC team for carrying out the challenging Sentinel-2 MSI project; we greatly appreciated.

We also express our warmest thanks to Didier Castel and David Denaux (ASTRIUM) for their very nice and fruitful collaboration on these projects.

Images courtesy of ASTRIUM and ESA

REFERENCES

1. Toulemont, Y., Doyle, D., Pierot, D. & Rivière, R. (2010) “Development and performances of the 3.5m all SiC telescope for HERSCHEL”, *Proceedings of OPTRO 2010, International Symposium on Optronics in Defence and Security, Space*, Paris, France, 3-5 February 2010.
2. Honnen, K., Kommer, A., Messerschmidt, B. & Wiehe, T., (2008) “NIRSpec OA development process of SiC components”, *Proceedings of SPIE, Astronomical Instrumentation*, Marseille, France, June 2008
3. Charvet, P., Pierot, D., Fruit, M., Coatantiec, C., & Garé, P., (2010) “The GAIA astrometry mission: status of optical development”, *Proceedings of OPTRO 2010, International Symposium on Optronics in Defence and Security, Space*, Paris, France, 3-5 February 2010.
4. Cazaubiel, V., Chorvalli, V., Delbru, F., Camus, F. & Arnoux, J.-J; (2010) “The optical telescope of the Sentinel-2 Multispectral Instrument”, *Proceedings of OPTRO 2010, International Symposium on*

Optronics in Defence and Security, Space, Paris, France, 3-5 February 2010.

5. Krödel, M., (2011) *HB-CeSiC® data sheet*, ECM company.
6. Charvet, P., Chassat, F., SAFA, F & SARRI, G., (2006) “GAIA payload module description”, *Proceedings of 6th International Conference on Space Optics*, ESTEC, Noordwijk, The Netherlands, 27-30 June 2006 (ESA SP-621, June 2006).
7. Garé, P., Sarri, G., & Schmidt, R., (2009) “ESA’s billion pixels camera, the challenges of the GAIA mission”, *European Space Agency, Bulletin 137*, pp. 51-59, February 2009.
8. Martimort, P., Berger, M., Carnicero, B., Del Bello, U., Fernandez, V., Gascon, F., Silvestrin, P., Spoto, F., Sy, O., ; (2007) “Sentinel-2, the optical high-resolution mission for GMES operational services ”, *ESA Bulletin 13*, August 2007.